

CENTURY



CENTURY

20th Anniversary Edition



The Finishing Touch



Century America, L.L.C., is honored to celebrate 20 years in business. Our philosophy, from the beginning, has been to design and create exquisite decorative cabinet hardware to adorn the cabinets of your home. Our commitment to excellence and outstanding customer service has not waived. We understand your need to have your purchase order fulfilled, when you need it and we continue to deliver at an impressive 99.3% fill rate.

From a simple concept drawn on a napkin, or an inspiration from the creative minds of our brilliant designers, Century continues to forge new horizons in cabinet hardware designs and finishes. Each piece is skillfully handcrafted using supreme, select materials and finishes. Century's collections are designed to celebrate your individuality. Whether your inspiration comes from Olde World Italian décor or an upscale metropolis, you're sure to find the perfect accent among Century's assortment of decorative knobs and pulls for your kitchen and bathroom. Highlight warm wood finishes with oil rubbed bronze or accent a modern motif with stainless steel or satin nickel.

We thank you for your continued support and business. We will look forward to many more years of successful business with you.

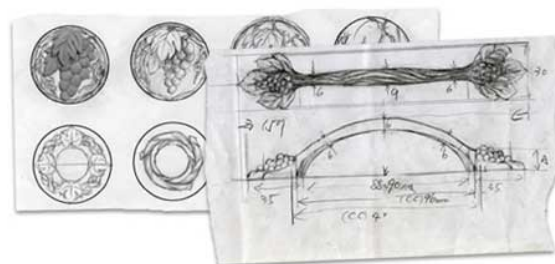

Century Showroom Display

Enhance your showroom by displaying Century's design collections. Each tower will hold up-to 16 collection boards, of your choice. Century's sleek display is designed to take-up very little floor space in your showroom. Our European style carousel measures only 16" X 16" X 70" and ships in an easy-to-assemble flat pack for normal ground service.

For added convenience, each display board is pre-assembled.

(The Iris Collection is equivalent to two display boards and the entire Stainless Steel Collection is equivalent to three display boards. Century also offers a nice assortment of the Stainless Steel pieces on a single-size display board.)

Venus

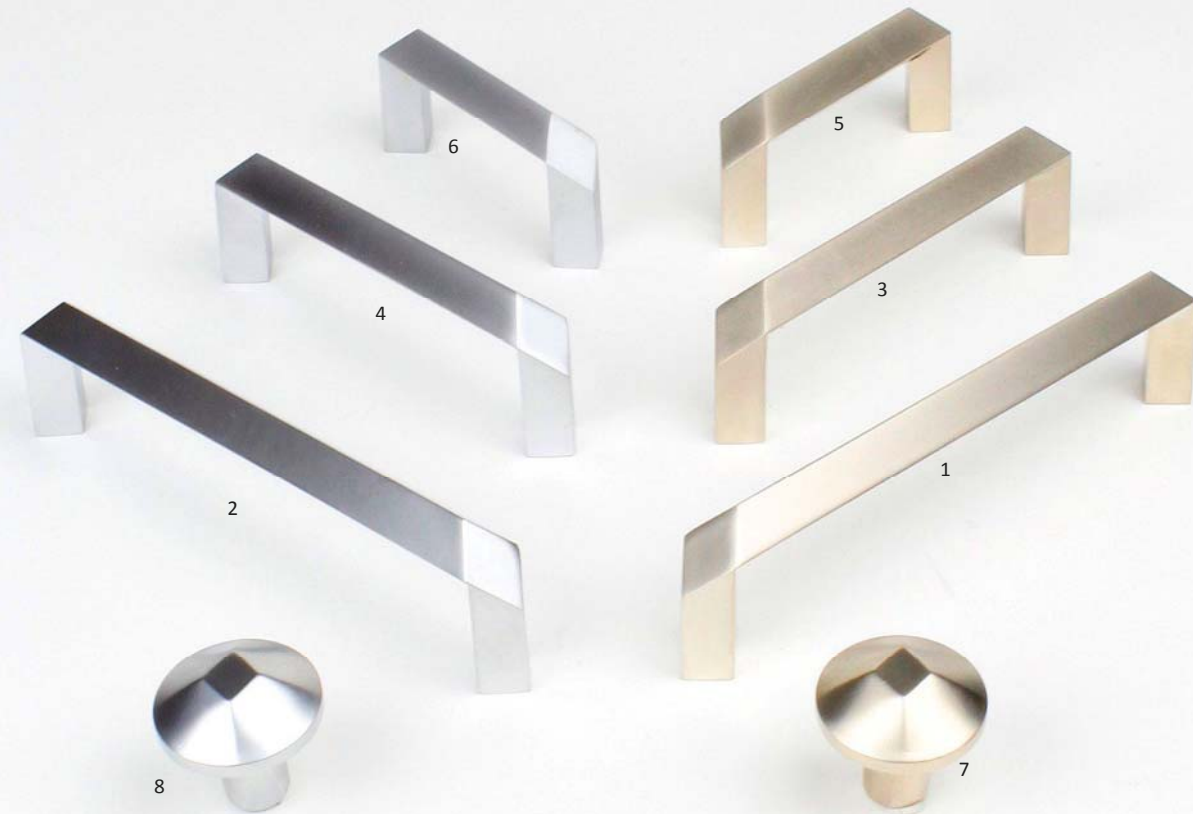

#	Part Number					Finishes
1.	24258-MNE	1-3/16"	1-3/8"	128 mm	5-9/16"	Matt Nickel Europe
2.	24258-DCE		1-3/8"	128 mm	5-9/16"	Dull Chrome Europe
3.	24256-MNE		1-3/8"	96 mm	4-5/16"	Matt Nickel Europe
4.	24256-DCE		1-3/8"	96 mm	4-5/16"	Dull Chrome Europe
5.	24251-MNE		1-3/8"	64 mm	3-1/16"	Matt Nickel Europe
6.	24251-DCE		1-3/8"	64 mm	3-1/16"	Dull Chrome Europe
7.	24305-MNE	1-3/16"	1-3/16"			Matt Nickel Europe
8.	24305-DCE	1-3/16"	1-3/16"			Dull Chrome Europe

Table of Contents





Introduction	2	Saxon Appliance Pull	22	Iris	42
Finish Codes	3	Appliance Pull	23	Metro	43
Serenity	4	Sunglow	24	Fairmont	44
Fiori	5	Vineyard	25	Apac	45
Monarch	6	Whistler	26	Country	46
Caledonia	7	Athena	27	Orchid	47
Volute	8	Aztec	28	Yukon	48
Villon	9	Tuscana	29	Yukon	49
Belvedere	10	Nordic I	30	Lisbon	50
Dolce	11	Nordic II	31	Milan	51
Regal	12	Devon	32	Saturn	52
Luna	13	Bocci	33	Brass Hinges	53
Aspen	14	Plymouth	34	Medieval	54
Cali	15	Orleans	35	Elite	55
Kentwood	16	Hartford	36	Stainless T-Handles	56
Baroque	17	Glacier	37	Stainless	57
Hamilton	18	Georgian	38	Venus	58
Hawthorne	19	Roman	39	Display Tower	59
Majestic	20	Tulip	40		
Highlander	21	Omega	41		

Finish Codes

3	Polished Brass, Bright Brass	AC	Aged Copper, Antique Copper	DSN	Dull Satin Nickel	RC	Regent Copper
3B	Aged English, Antique Bronze	ACH	Brushed Antique Copper	GB	German Bronze	RE	Regent English
4	Satin Brass	AI	Aged Iron	GM	Gun Metal	RZC	Regent Bronze/Copper
10B	Oil Rubbed Bronze	ALB	Antique Light Brass	IB	Imperial Bronze	RS	Regent Silver
14	Polished Nickel	AN	Antique Nickel	MB	Matt Black	VP	Vibra Pewter
15	Satin Nickel	AP	Aged Pewter, Antique Pewter	MNE	Matt Nickel Europe	VS	Vintage Silver
15CR	Satin Nickel/Cream Crackle	APGY	Antique Pewter/Gray Crackle	MSN	Matt Satin Nickel	WB	Weathered Brass
15WT	Satin Nickel/White Ceramic	APH	Antique Pewter Hand Polished	NB	Black Nickel	WN	Weathered Nickel
26	Polished Chrome	APM	Antique Pewter	NR	Natural Rust	WNC	Weathered Nickel/Copper
26BK	Polished Chrome/Plain Black	AS	Antique Silver	OB	Oil Rubbed Bronze	WP	Weathered Pewter
26WT	Polished Chrome/White Ceramic	ASH	Antique Pewter	OBBC	Oil Rubbed Bronze/Brown Crackle	WZC	Weathered Bronze/Copper
AB	Brushed Antique Brass	AZ	Aged Bronze	OBL	Light Oil Rubbed Bronze	WZ	Weathered Bronze
ABH	Brushed Antique Brass	AZC	Antique Bronze/Copper	OI	Olde Iron Rust		
ABM	Antique Brass	BNB	Brushed Black Nickel	PA	Polished Antique		
ABZ	Ancient Bronze	DCE	Dull Chrome Europe	RB	Regent Bronze		

Serenity







#	Part Number					Finishes
1.	27819-AZC	5/8"	1-3/16"		2"	Antique Bronze/Copper
2.	27819-OB	5/8"	1-3/16"		2"	Oil Rubbed Bronze
3.	27819-DSN	5/8"	1-3/16"		2"	Dull Satin Nickel
4.	27819-IB	5/8"	1-3/16"		2"	Imperial Bronze
5.	27878-AZC		1-1/4"	128 mm	5-7/8"	Antique Bronze/Copper
6.	27878-OB		1-1/4"	128 mm	5-7/8"	Oil Rubbed Bronze
7.	27878-DSN		1-1/4"	128 mm	5-7/8"	Dull Satin Nickel
8.	27878-IB		1-1/4"	128 mm	5-7/8"	Imperial Bronze

Patent Pending

Stainless

Premium Grade Stainless Steel



#	Part Number				
1.	40536-32D	10 mm	1-1/4"	96 mm	106 mm
2.	40538-32D	10 mm	1-1/4"	128 mm	138 mm
3.	40539E-32D	10 mm	1-1/4"	288 mm	298 mm
4.	40546-32D	10 mm	1-1/8"	96 mm	115 mm
5.	40548-32D	10 mm	1-1/8"	128 mm	152.5 mm
6.	40549E-32D	10 mm	1-1/8"	288 mm	335 mm
7.	40502-32D	12 mm	1-3/8"		1-3/8"
8.	40425-32D	1-3/16"	7/8"		
9.	40511-32D	5/8"	1-1/8"		
10.	40501-32D	3/4"	1-1/8"		

Stainless

Premium Grade Stainless Steel



#	Part Number				
1.	40456-32D	12 mm	1-3/8"	96 mm	156 mm
2.	40458-32D	12 mm	1-3/8"	128 mm	188 mm
3.	40459A-32D	12 mm	1-3/8"	160 mm	220 mm
4.	40459C-32D	12 mm	1-3/8"	224 mm	284 mm
5.	40459E-32D	12 mm	1-3/8"	288 mm	348 mm

Additional Available T-Handle Sizes

40459H-32D	12 mm	1-3/8"	384 mm	444 mm
40459J-32D	12 mm	1-3/8"	448 mm	508 mm
40459M-32D	12 mm	1-3/8"	544 mm	604 mm
40459P-32D	12 mm	1-3/8"	640 mm	700 mm
40459S-32D	12 mm	1-3/8"	736 mm	796 mm
40459V-32D	12 mm	1-3/8"	832 mm	892 mm

Fiori

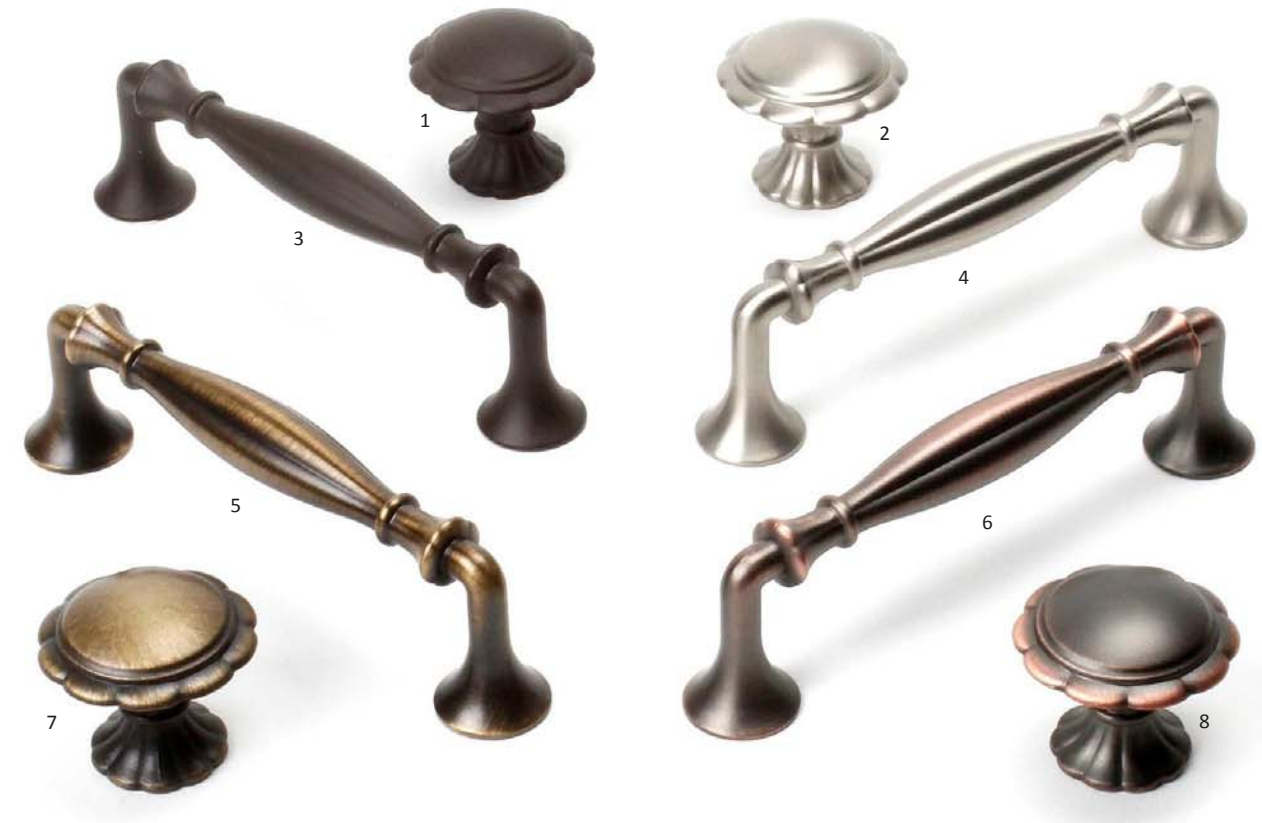

#	Part Number					Finishes
1.	27807-OB	1-3/8"	1-1/8"			Oil Rubbed Bronze
2.	27807-DSN	1-3/8"	1-1/8"			Dull Satin Nickel
3.	27867-OB		1-3/16"	4"	4-6/8"	Oil Rubbed Bronze
4.	27867-DSN		1-3/16"	4"	4-6/8"	Dull Satin Nickel
5.	27867-IB		1-3/16"	4"	4-6/8"	Imperial Bronze
6.	27867-AZC		1-3/16"	4"	4-6/8"	Antique Bronze/Copper
7.	27807-IB	1-3/8"	1-1/8"			Imperial Bronze
8.	27807-AZC	1-3/8"	1-1/8"			Antique Bronze/Copper

Monarch



#	Part Number					Finishes
1.	29316-DSN	1"	1-1/16"		1-1/4"	Dull Satin Nickel
2.	29368-DSN		1-1/4"	128 mm	5-7/8"	Dull Satin Nickel
3.	29368-AB		1-1/4"	128 mm	5-7/8"	Brushed Antique Brass
4.	29316-AB	1"	1-1/16"		1-1/4"	Brushed Antique Brass
5.	29316-AP	1"	1-1/16"		1-1/4"	Antique Pewter
6.	29368-AP		1-1/4"	128 mm	5-7/8"	Antique Pewter
7.	29368-AZC		1-1/4"	128 mm	5-7/8"	Antique Bronze/Copper
8.	29316-AZC	1"	1-1/16"		1-1/4"	Antique Bronze/Copper

Elite



#	Part Number					Additional Available Finishes
1.	10306-15	oval	1-15/16"		1-1/4"	NB
2.	13036-15		1"	96 mm	4-1/8"	NB, 4
3.	12405-15	1-1/4"	1-1/8"			NB, 4
4.	10302-15	oval	1"		1"	NB
5.	13033-15		7/8"	3"	3-7/16"	NB, 4

Medieval

Caledonia



#	Part Number					Additional Available Finishes
1.	25346-DSN		1-1/16"	96 mm	4-11/16"	OI, 26, VP, WNC
2.	20858-DSN		1-3/4"	128 mm	5-13/16"	OI, 26, VP, WNC
3.	25115-DSN	1-3/16"	1"			OI, 26, VP, WNC

#	Part Number					Finishes
1.	29427-MSN	1-3/8"	7/8"			Matt Satin Nickel
2.	29427-RS	1-3/8"	7/8"			Regent Silver
3.	29477-MSN		3/4"	4"	5-1/16"	Matt Satin Nickel
4.	29477-RS		3/4"	4"	5-1/16"	Regent Silver
5.	29477-OB		3/4"	4"	5-1/16"	Oil Rubbed Bronze
6.	29477-AZC		3/4"	4"	5-1/16"	Antique Bronze/Copper
7.	29427-OB	1-3/8"	7/8"			Oil Rubbed Bronze
8.	29427-AZC	1-3/8"	7/8"			Antique Bronze/Copper

Volute







Antique Bronze/Copper (-AZC)



Dull Satin Nickel (-DSN)



Oil Rubbed Bronze (-OB)

#	Part Number					Additional Available Finishes
1.	24919-AZC	5/8"	6/8"		1-5/16"	DSN, OB
2.	24963-AZC		1"	3"	3-5/8"	DSN, OB
3.	24958-AZC		1-1/8"	128 mm	6-7/8"	DSN, OB
4.	24955-AZC		1-3/16"	3-1/2"	4-7/8"	DSN, OB

US Design Patents: 24919: USPN D626399, 24963: USPN D627620, 24958, 24955: USPN D602758

Hinges

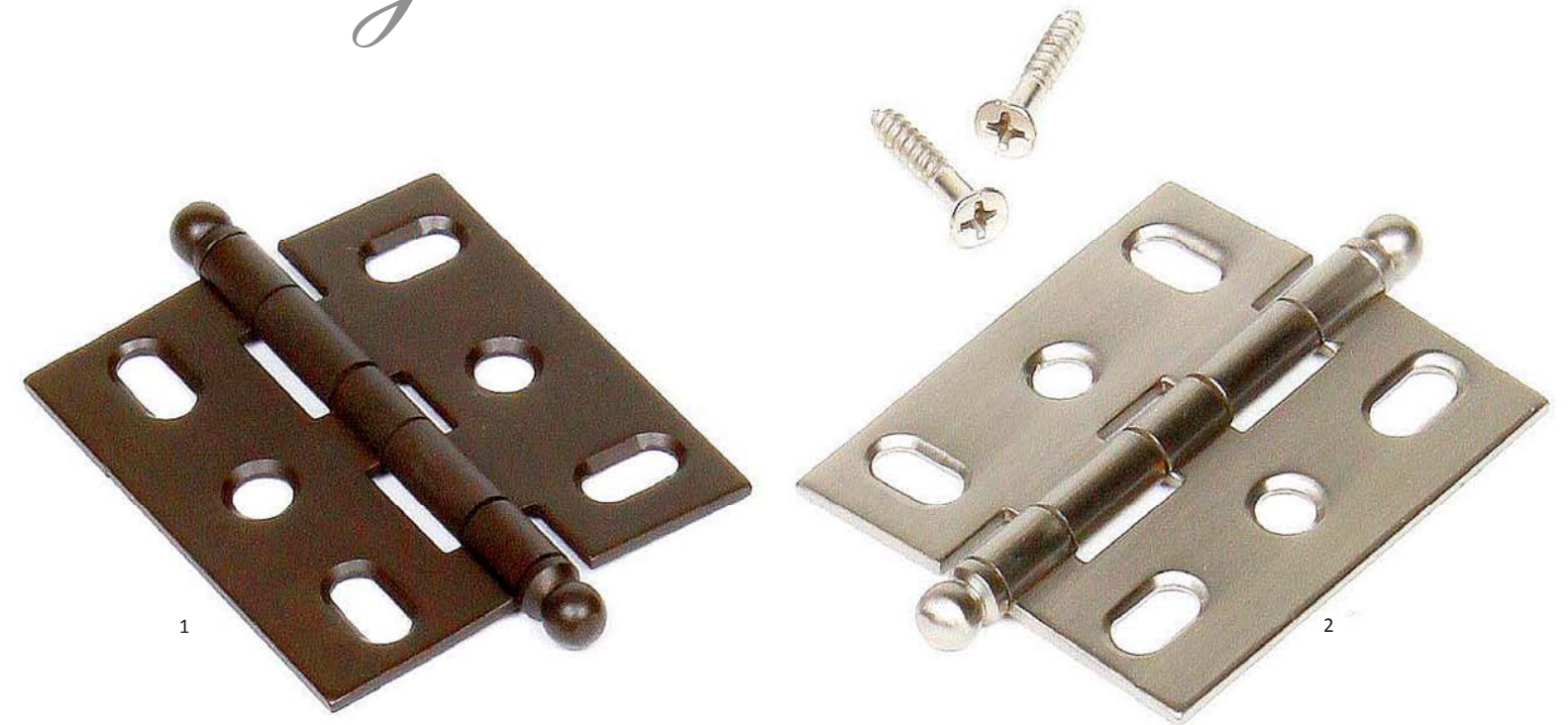

Oil Rubbed Bronze (-10B)

Matt Satin Nickel (-MSN)



Dull Satin Nickel (-DSN)



Weathered Brass (-WB)



Weathered Pewter (-WP)

#	Part Number		Additional Available Finishes
1.	72042-10B	1-3/4" X 2-1/2"	DSN, WB, WP
2.	72042-MSN	1-3/4" X 2-1/2"	DSN, WB, WP

Saturn

Premium Hollow Brass Knobs



Back Plate included where shown

#	Part Number			Finishes
1.	15016-10B	1-1/4"	1-1/4"	Oil Rubbed Bronze
2.	15056-3B	1-1/4"	1-3/8"	Aged English
3.	15056-AP	1-1/4"	1-3/8"	Aged Pewter
4.	15056-AS	1-1/4"	1-3/8"	Aged Silver
5.	15056-AC	1-1/4"	1-3/8"	Aged Copper
6.	15056-DSN	1-1/4"	1-3/8"	Dull Satin Nickel
7.	12016-15	1-1/4"	1-1/16"	Satin Nickel
8.	12016-AP	1-1/4"	1-1/16"	Aged Pewter
9.	12016-NB	1-1/4"	1-1/16"	Black Nickel
10.	12016-26	1-1/4"	1-1/16"	Polished Chrome
11.	12016-10B	1-1/4"	1-1/16"	Oil Rubbed Bronze
12.	15026-15	1-1/4"	1-7/16"	Satin Nickel

Villon

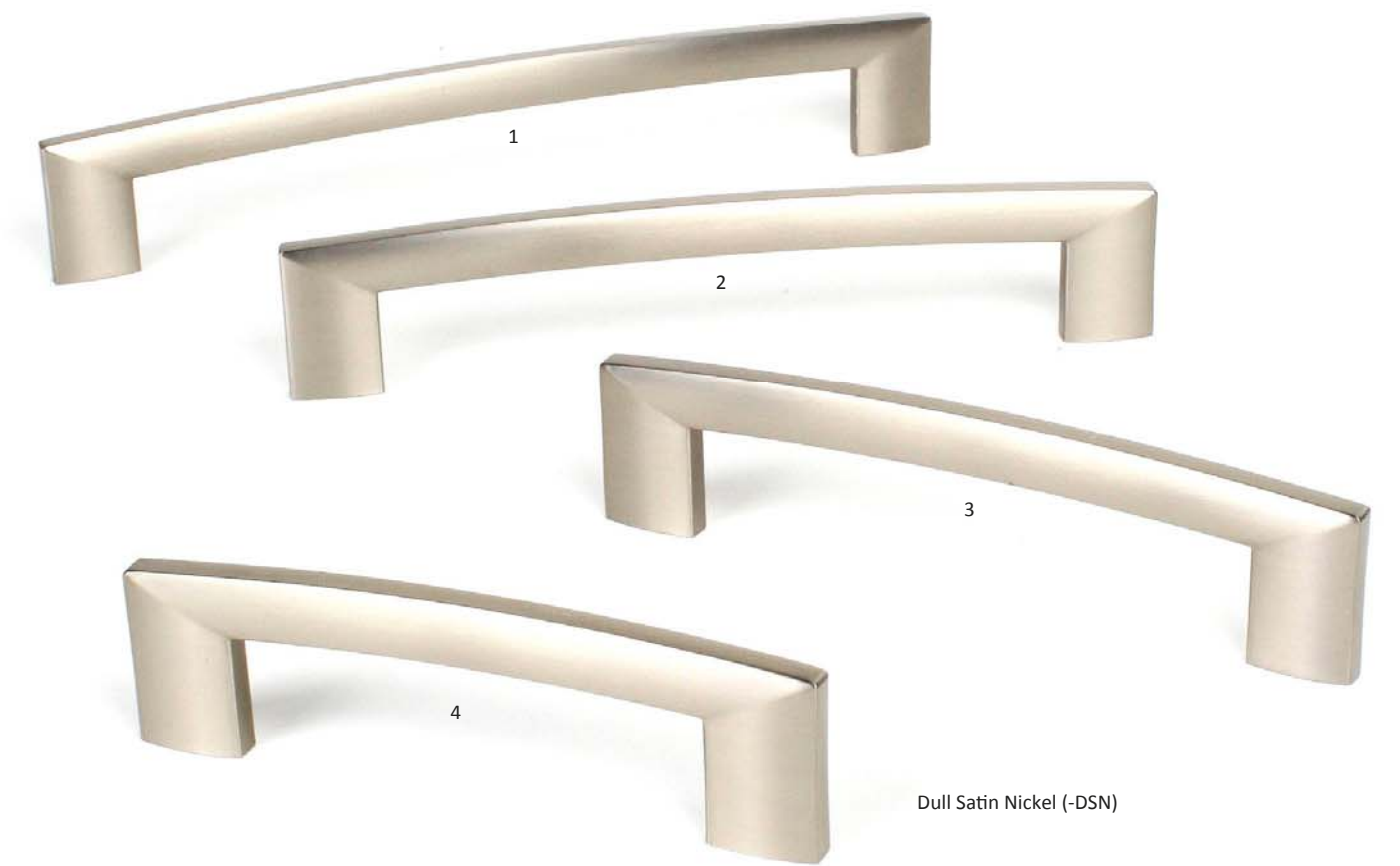

Dull Satin Nickel (-DSN)

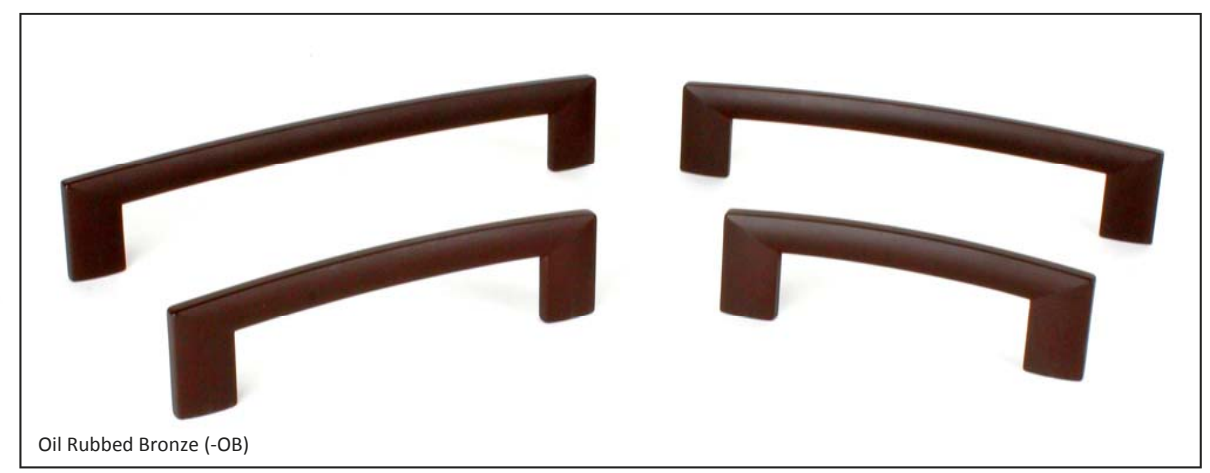





Oil Rubbed Bronze (-OB)





#	Part Number				Additional Available Finishes
1.	24479-DSN	1-3/16"	192 mm	8-5/16"	OB
2.	24469-DSN	1-3/16"	160 mm	7-1/16"	OB
3.	24468-DSN	1-1/8"	128 mm	5-3/4"	OB
4.	24467-DSN	1-1/8"	4"	4-3/4"	OB

Belvedere

Milan



#	Part Number					Finishes
1.	29407-OB	1-3/8"	1"			Oil Rubbed Bronze
2.	29407-RS	1-3/8"	1"			Regent Silver
3.	29467-OB		1"	4"	4-3/4"	Oil Rubbed Bronze
4.	29467-RS		1"	4"	4-3/4"	Regent Silver
5.	29467-MSN		1"	4"	4-3/4"	Matt Satin Nickel
6.	29467-AZC		1"	4"	4-3/4"	Antique Bronze/Copper
7.	29407-MSN	1-3/8"	1"			Matt Satin Nickel
8.	29407-AZC	1-3/8"	1"			Antique Bronze/Copper

#	Part Number					Finishes
1.	28443-GM		1-5/16"	3"	3-7/16"	Gun Metal
2.	28443-15		1-5/16"	3"	3-7/16"	Satin Nickel
3.	28443-3B		1-5/16"	3"	3-7/16"	Antique Bronze
4.	21143-3B		15/16"	3"	4-13/16"	Antique Bronze
5.	21143-GM		15/16"	3"	4-13/16"	Gun Metal
6.	21143-15		15/16"	3"	4-13/16"	Satin Nickel
7.	20606-GM	1-1/4"	1-1/4"			Gun Metal
8.	20606-3B	1-1/4"	1-1/4"			Antique Bronze
9.	20606-15	1-1/4"	1-1/4"			Satin Nickel

Lisbon

Dolce



#	Part Number					Additional Available Finishes
1.	21843-15		15-/16"	3"	3.-3/4"	APH, ACH, BNB
2.	21456-15		15/16"	96 mm	5-1/4"	APH, ACH, BNB
3.	20304-15	1-3/16"	1-3/16"			APH, ACH, BNB
4.	21416-15	1-1/4"	1-1/16"			APH, ACH, BNB
5.	21446-15		1-1/16"	96 mm	4-5/16"	APH, ACH, BNB

#	Part Number					Finishes
1.	28800-OBL	2-5/8"	1-1/4"	32 mm	1-15/16"	Light Oil Rubbed Bronze
2.	28800-APH	2-5/8"	1-1/4"	32 mm	1-15/16"	Antique Pewter Hand Polished
3.	28800-AZC	2-5/8"	1-1/4"	32 mm	1-15/16"	Antique Bronze/Copper
4.	28919-OBL	1-3/4"	1-3/16"			Light Oil Rubbed Bronze
5.	28919-APH	1-3/4"	1-3/16"			Antique Pewter Hand Polished
6.	28919-AZC	1-3/4"	1-3/16"			Antique Bronze/Copper

Regal



Dull Satin Nickel (-DSN)



Antique Pewter Hand Polished (-APH)



Oil Rubbed Bronze (-OB)

#	Part Number					Additional Available Finishes
1.	22198-DSN		1-1/4"	128 mm	6"	APH, OB
2.	22197-DSN		1-1/4"	4"	4-15/16"	APH, OB
3.	22205-DSN	1-3/16"	1-3/16"			APH, OB

US Design Patents: 22205: USPN D565385

Yukon



Weathered Bronze/Copper (-WZC)



Matt Satin Nickel (-MSN)



Oil Rubbed Bronze (-10B)





#	Part Number					Additional Available Finishes
1.	18143-WZC		15/16"	3"	3-13/16"	MSN, 10B
2.	19353-WZC		1-1/8"	3"	3-3/4"	MSN, 10B
3.	18137-WZC		1-3/16"	4"	5-1/8"	MSN, 10B
4.	18126-WZC	1-1/4"	1-1/4"			MSN, 10B
5.	15243-WZC		1-1/16"	3"	4-1/8"	MSN, 10B
6.	13337-WZC		1-1/8"	4"	4-7/16"	MSN, 10B
7.	18128-WZC	1-1/2"	1-1/2"			MSN, 10B
8.	12405-WZC	1-1/4"	1-1/8"			MSN, 10B
9.	13333-WZC		15/16"	3"	3-3/8"	MSN, 10B
10.	16369-WZC	1-1/2"	1/8"			MSN, 10B

Please note: slight variations in color are an inherent feature of some finishes and only serve to enhance the final appearance



Luna



#	Part Number					Finishes
1.	28024-RC	1-1/8"	1-3/16"			Regent Copper
2.	28024-APH	1-1/8"	1-3/16"			Antique Pewter Hand Polished
3.	28038-RC		1-3/8"	128 mm	6-5/16"	Regent Copper
4.	28038-APH		1-3/8"	128 mm	6-5/16"	Antique Pewter Hand Polished
5.	28038-RZC		1-3/8"	128 mm	6-5/16"	Regent Bronze/Copper
6.	28038-RE		1-3/8"	128 mm	6-5/16"	Regent English
7.	28024-RZC	1-1/8"	1-3/16"			Regent Bronze/Copper
8.	28024-RE	1-1/8"	1-3/16"			Regent English

US Design Patents: 28024: USPN D583647, 28038: USPN D584593

Please note: slight variations in color are an inherent feature of some finishes and only serve to enhance the final appearance

Aspen



#	Part Number					Finishes
1.	23025-GM	1-3/16"	1-1/8"			Gun Metal
2.	23025-DSN	1-3/16"	1-1/8"			Dull Satin Nickel
3.	23033-GM		1"	3"	5"	Gun Metal
4.	23033-DSN		1"	3"	5"	Dull Satin Nickel
5.	23033-APH		1"	3"	5"	Antique Pewter Hand Polished
6.	23033-RB		1"	3"	5"	Regent Bronze
7.	23025-APH	1-3/16"	1-1/8"			Antique Pewter Hand Polished
8.	23025-RB	1-3/16"	1-1/8"			Regent Bronze





Orchid



#	Part number					Finishes
1.	26046-ACH		1"	96 mm	5"	Brushed Antique Copper
2.	26709-ACH	oval	1-1/16"		1-5/8"	Brushed Antique Copper
3.	26709-APH	oval	1-1/16"		1-5/8"	Antique Pewter Hand Polished
4.	26046-APH		1"	96 mm	5"	Antique Pewter Hand Polished
5.	26046-BNB		1"	96 mm	5"	Brushed Black Nickel
6.	26709-BNB	oval	1-1/16"		1-5/8"	Brushed Black Nickel
7.	26709-15	oval	1-1/16"		1-5/8"	Satin Nickel
8.	26046-15		1"	96 mm	5"	Satin Nickel
9.	26046-ABH		1"	96 mm	5"	Brushed Antique Brass
10.	26709-ABH	oval	1-1/16"		1-5/8"	Brushed Antique Brass
11.	26046-GM		1"	96 mm	5"	Gun Metal
12.	26709-GM	oval	1-1/16"		1-5/8"	Gun Metal





Country



#	Part Number					Finishes
1.	29225-DSN	1-3/16"	1"			Dull Satin Nickel
2.	29227-DSN	1-3/8"	1-3/16"			Dull Satin Nickel
3.	29227-WNC	1-3/8"	1-3/16"			Weathered Nickel/Copper
4.	29225-WNC	1-3/16"	1"			Weathered Nickel/Copper
5.	25036-DSN		1-3/16"	96 mm	4-1/8"	Dull Satin Nickel
6.	25036-WNC		1-3/16"	96 mm	4-1/8"	Weathered Nickel/Copper

Cali



#	Part Number					Finishes
1.	25463-APH		1"	3"	3-11/16"	Antique Pewter Hand Polished
2.	25476-APH		1-3/16"	96 mm	4-3/16"	Antique Pewter Hand Polished
3.	25505-APH	1-1/4"	1-3/16"			Antique Pewter Hand Polished
4.	25463-OB		1"	3"	3-11/16"	Oil Rubbed Bronze
5.	25476-OB		1-3/16"	96 mm	4-3/16"	Oil Rubbed Bronze
6.	25505-OB	1-1/4"	1-3/16"			Oil Rubbed Bronze

US Design Patents: 25463: USPN D575620, 25476: USPN D574218, 25505: USPN D579749

Kentwood

Apac



Dull Satin Nickel (-DSN)

Antique Bronze/Copper (-AZC)



Gun Metal (-GM)

Oil Rubbed Bronze (-OB)

German Bronze (-GB)

#	Part Number					Additional Available Finishes
1.	22936-AZC		1-1/4"	96 mm	4-15/16"	GM, OB, GB
2.	22926-AZC	1-1/4"	1-1/4"			GM, OB, GB
3.	22936-DSN		1-1/4"	96 mm	4-15/16"	GM, OB, GB
4.	22926-DSN	1-1/4"	1-1/4"			GM, OB, GB

US Design Patents: 22936: USPN D553944, 22926: USPN D558557



#	Part Number					Finishes
1.	25753-15		1"	3"	4-9/16"	Satin Nickel
2.	25753-OB		1"	3"	4-9/16"	Oil Rubbed Bronze
3.	24943-15		1-3/16"	3"	4-5/8"	Satin Nickel
4.	24943-OB		1-3/16"	3"	4-5/8"	Oil Rubbed Bronze
5.	25815-15	1-3/16"	1"			Satin Nickel
6.	25815-OB	1-3/16"	1"			Oil Rubbed Bronze
7.	21015-OB	1-1/4"	1"			Oil Rubbed Bronze
8.	21015-15	1-1/4"	1"			Satin Nickel
9.	23853-OB		1-5/16"	3"	3-3/8"	Oil Rubbed Bronze
10.	23853-15		1-5/16"	3"	3-3/8"	Satin Nickel

Please note: slight variations in color are an inherent feature of some finishes and only serve to enhance the final appearance

Fairmont



Dull Chrome Europe (-DCE)



Matt Nickel Europe (-MNE)

#	Part Number					Additional Available Finishes
1.	29003-DCE		1-1/8"	160 mm	7"	MNE
2.	29348-DCE		1-3/16"	128 mm	5-1/2"	MNE
3.	29346-DCE		1-3/16"	96 mm	4-1/2"	MNE
4.	29004-DCE		1-1/8"	224 mm	9-1/2"	MNE
5.	29002-DCE	3/4"	1-1/16"			MNE

Baroque



Dull Satin Nickel (-DSN)

Oil Rubbed Bronze (-OB)



Antique Pewter (-AP)

Matt Black (-MB)





Antique Pewter Hand Polished (-APH)

Antique Bronze (-3B)

#	Part Number					Additional Available Finishes
1.	23617-DSN	1-3/8"	1-3/16"			OB, AP, MB, APH, 3B
2.	23617-OB	1-3/8"	1-3/16"			DSN, AP, MB, APH, 3B
3.	25143-DSN		1"	3"	5-5/8"	OB, AP, MB, APH, 3B
4.	25143-OB		1"	3"	5-5/8"	DSN, AP, MB, APH, 3B

Hamilton





#	Part Number					Finishes
1.	28605-AC	1-3/16"	1-3/16"			Antique Copper
2.	28605-3B	1-3/16"	1-3/16"			Antique Bronze
3.	28605-AP	1-3/16"	1-3/16"			Antique Pewter
4.	28605-OB	1-3/16"	1-3/16"			Oil Rubbed Bronze
5.	28598-3B		1-1/4"	128 mm	6-1/4"	Antique Bronze
6.	28598-AC		1-1/4"	128 mm	6-1/4"	Antique Copper
7.	28598-OB		1-1/4"	128 mm	6-1/4"	Oil Rubbed Bronze
8.	28598-AP		1-1/4"	128 mm	6-1/4"	Antique Pewter

US Design Patents: 28605: USPN D553942, 28598: USPN D554466

Please note: slight variations in color are an inherent feature of some finishes and only serve to enhance the final appearance

Metro



#	Part Number				Additional Available Finishes
1.	28169-15	1-5/16"	224 mm	11-1/4"	Oil Rubbed Bronze (-OB)
2.	28168-OB	1-1/4"	128 mm	6-1/4"	Satin Nickel (-15)
3.	28166-15	15/16"	96 mm	4-1/2"	Oil Rubbed Bronze (-OB)
4.	28162-OB	7/8"	70 mm	3-1/4"	Satin Nickel (-15)

Please note: slight variations in color are an inherent feature of some finishes and only serve to enhance the final appearance

Iris







Antique Bronze/Copper (-AZC)



Light Oil Rubbed Bronze (-OBL)



Dull Satin Nickel (-DSN)

#	Part Number					Additional Available Finishes
1.	28049-AZC		1-3/4"	8"	11"	DSN, OBL
2.	28046-AZC		1-1/8"	96 mm	5-3/8"	DSN, OBL
3.	28043-AZC		7/8"	3"	4-1/4"	DSN, OBL
4.	28017-AZC	1-3/8"	1-1/4"			DSN, OBL
5.	28015-AZC	1-3/16"	1"			DSN, OBL

US Design Patents: 28049, 28046, 28043: USPN D582247, 28017, 28015: USPN D574212

Hawthorne



Antique Pewter (-AP)





German Bronze (-GB)



Dull Satin Nickel (-DSN)



Oil Rubbed Bronze (-OB)

#	Part Number					Finishes
1.	22366-AP		1-1/4"	96 mm	4-5/16"	OB, DSN
2.	22326-AP		1-1/4"			OB, DSN
3.	22307-AP	oval	1-1/4"		1-3/8"	OB, DSN
4.	22366-GB		1-1/4"	96 mm	4-5/16"	OB, DSN
5.	22326-GB		1-1/4"			OB, DSN
6.	22307-GB	oval	1-1/4"		1-3/8"	OB, DSN

Majestic



Dull Satin Nickel (-DSN)



Brushed Black Nickel (-BNB)



Matt Black (-MB)

#	Part Number					Additional Available Finishes
1.	29553-DSN		7/8"	3"	4-5/16"	BNB, MB
2.	29517-DSN	1-3/8"	1-1/8"			BNB, MB
3.	29515-DSN	1-3/16"	1"			BNB, MB
4.	29533-DSN		7/8"	3"	4-5/16"	BNB, MB

Omega



#	Part Number					Finishes
1.	29706-AP		1-3/16"	96 mm	4-1/8"	Antique Pewter
2.	20907-AP	1-3/8"	1-3/16"			Antique Pewter
3.	20907-RE	1-3/8"	1-3/16"			Regent English
4.	29706-RE		1-3/16"	96 mm	4-1/8"	Regent English
5.	29706-RZC		1-3/16"	96 mm	4-1/8"	Regent Bronze/Copper
6.	20907-RZC	1-3/8"	1-3/16"			Regent Bronze/Copper

Tulip



#	Part Number					Additional Available Finishes
1.	24171-AZC		1-1/4"	64 mm	3"	Antique Bronze/Copper
2.	24171-APH		1-1/4"	64 mm	3"	Antique Pewter Hand Polished
3.	24171-OBL		1-1/4"	64 mm	3"	Light Oil Rubbed Bronze
4.	24215-APH	1-3/16"	1"			Antique Pewter Hand Polished
5.	24166-APH		15/16"	96 mm	4-15/16"	Antique Pewter Hand Polished
6.	24166-AZC		15/16"	96 mm	4-15/16"	Antique Bronze/Copper
7.	24166-OBL		15/16"	96 mm	4-15/16"	Light Oil Rubbed Bronze
8.	24215-AZC	1-3/16"	1"			Antique Bronze/Copper
9.	24215-OBL	1-3/16"	1"			Light Oil Rubbed Bronze

Highlander



Antique Pewter Hand Polished (-APH)



Dull Satin Nickel (-DSN)



Weathered Bronze (-WZ)





Weathered Brass (-WB)

#	Part Number					Additional Available Finishes
1.	29217-APH	1-3/8"	1-3/16"			DSN, WZ, WB
2.	29253-APH		3/4"	3"	4-3/4"	DSN, WZ, WB
3.	29153-APH		1"	3"	4-3/8"	DSN, WZ, WB
4.	29215-APH	1-3/16"	1"			DSN, WZ, WB

Saxon Appliance Pull







#	Part Number				Finishes
1.	42449D-MB	2-9/16"	10"	10-3/4"	Matt Black
2.	42449B-MB	2-9/16"	8"	8-3/4"	Matt Black
3.	42449D-NR	2-9/16"	10"	10-3/4"	Natural Rust
4.	42449B-NR	2-9/16"	8"	8-3/4"	Natural Rust
5.	42449D-WI	2-9/16"	10"	10-3/4"	Wrought Iron
6.	42449B-WI	2-9/16"	8"	8-3/4"	Wrought Iron
7.	42429-MB	1-15/16"		3-1/2"	Matt Black
8.	42428-MB	1-9/16"		2-3/4"	Matt Black
9.	42429-WI	1-15/16"		3-1/2"	Wrought Iron
10.	42428-WI	1-9/16"		2-3/4"	Wrought Iron
11.	42429-NR	1-15/16"		3-1/2"	Natural Rust
12.	42428-NR	1-9/16"		2-3/4"	Natural Rust

Roman



Matt Satin Nickel (-MSN)

Oil Rubbed Bronze (-10B)

#	Part Number					Finishes
1.	19343-MSN		1-3/8"	3"	3-9/16"	MSN
2.	19308-MSN	1-1/2"	1-1/2"			MSN
3.	19306-MSN	1-1/4"	1-1/4"			MSN
4.	19343-10B		1-3/8"	3"	3-9/16"	10B
5.	19306-10B	1-1/4"	1-1/4"			10B
6.	19308-10B	1-1/2"	1-1/2"			10B

Georgian

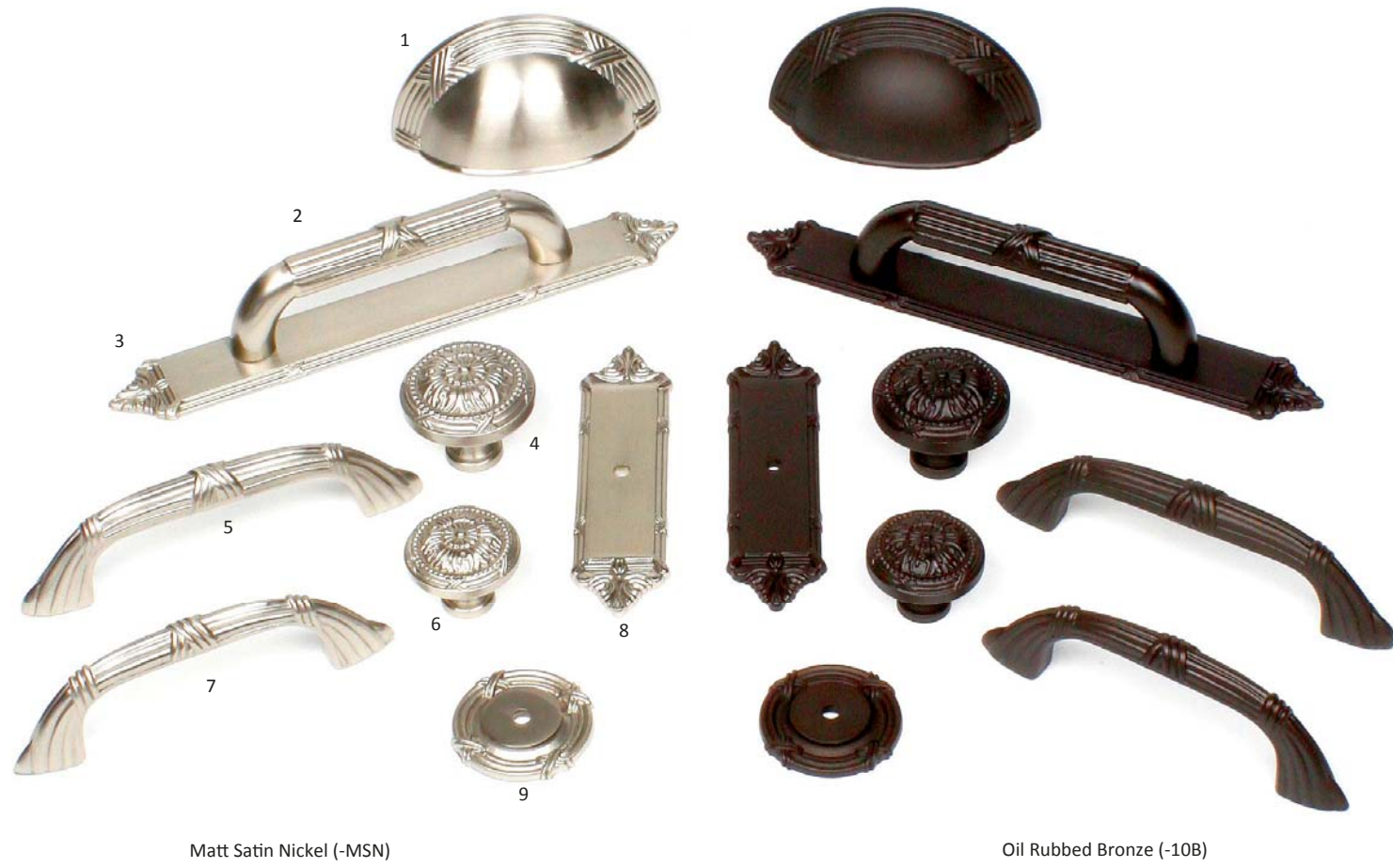

Matt Satin Nickel (-MSN)

Oil Rubbed Bronze (-10B)

#	Part Number				Additional Available Finishes	
1.	15543-MSN		1-1/16"	3"	3-7/16"	10B
2.	15156-MSN		1-3/16"	96 mm	4-1/4"	10B
3.	16069-MSN		1/8"	96 mm	7-3/16"	10B
4.	18018-MSN	1-1/2"	1-5/16"			10B
5.	15535-MSN		1-1/4"	3-1/2"	4-5/8"	10B
6.	18016-MSN	1-1/4"	1-1/8"		4-3/16"	10B
7.	15533-MSN		1-1/4"	3"	4-3/16"	10B
8.	16079-MSN		1/8"		4-3/16"	10B
9.	18069-MSN	1-1/2"	1/8"			10B

Appliance Pull

1



Polished Antique (-PA)

Matt Satin Nickel (-MSN)

Oil Rubbed Bronze (-10B)

Pictured with Georgian 15156-PA, MSN and 10B

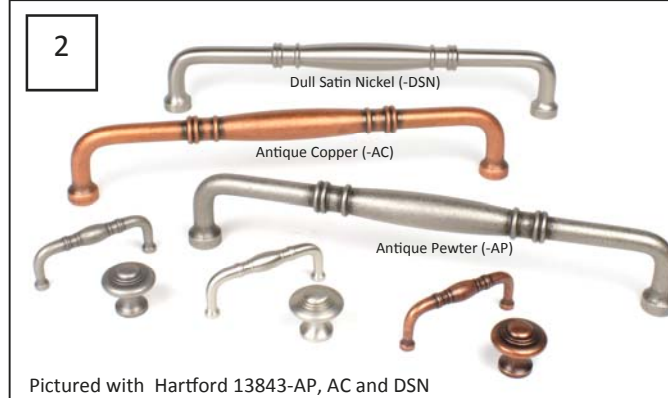

Dull Satin Nickel (-DSN)

Antique Copper (-AC)

Antique Pewter (-AP)

Pictured with Hartford 13843-AP, AC and DSN



Oil Rubbed Bronze (-10B)

Matt Satin Nickel (-MSN)

Weathered Bronze/Copper (-WZC)

Pictured with Yukon 13337-10B, MSN, WZC

#	Part Number				Available Finishes
1.	15159D	2-7/16"	10"	10-3/4"	PA, MSN, 10B
2.	13849E	2-1/2"	12"	12-7/8"	DSN, AC, AP
3.	13339D	2-1/8"	10"	10-5/8"	10B, MSN, WZC

Sunglow



#	Part Number					Finishes
1.	25773-AZC		1-1/4"	3"	4"	Antique Bronze/Copper
2.	25773-AP		1-1/4"	3"	4"	Antique Pewter
3.	26005-AZC	1-3/16"	1-3/16"			Antique Bronze/Copper
4.	25766-AZC		1-3/16"	96 mm	4-3/8"	Antique Bronze/Copper
5.	25766-AZC		1-3/16"	96 mm	4-3/8"	Antique Pewter
6.	26005-AP	1-3/16"	1-3/16"			Antique Pewter

US Design Patents: 25773: USPN D574216, 26005: USPN D585263, 25766: USPN D574217

Glacier



#	Part Number					Additional Available Finishes
1.	22531-OBL		1"	64 mm	4-1/16"	DSN, AZC, WN, WP
2.	20205-OBL	1-3/16"	1-3/16"			DSN, AZC, WN, WP
3.	21123-OBL		1-1/4"	3"	5"	DSN, AZC, WN, WP
4.	27117-OBL	oval	1-1/4"		1-3/8"	DSN, AZC, WN, WP
5.	27129-OBL	1-1/2"	1"			DSN, AZC, WN, WP

Please note: slight variations in color are an inherent feature of some finishes and only serve to enhance the final appearance

Hartford



Dull Satin Nickel (-DSN)



Antique Copper (-AC)



Antique Pewter (-AP)

#	Part Number					Additional Available Finishes
1.	13543-DSN		1"	3"	4-5/8"	AC, AP
2.	13553-DSN		1-1/4"	3"	3-3/4"	AC, AP
3.	14943-DSN		1-1/8"	3"	4-5/8"	AC, AP
4.	12405-DSN	1-1/4"	1-1/8"			AC, AP
5.	15326-DSN	1-1/4"	1-1/16"			AC, AP
6.	12816-DSN	1-1/4"	1"			AC, AP
7.	13843-DSN		1-1/4"	3"	3-3/8"	AC, AP
8.	15825-DSN	1-3/16"	1"			AC, AP
9.	13853-DSN		1-1/4"	3"	3-3/8"	AC, AP
10.	12927-DSN	1-3/8"	1-1/4"			AC, AP

Vineyard



Weathered Bronze/Copper (-WZC)



Antique Nickel (-AN)







Antique Light Brass (-ALB)

#	Part Number					Additional Available Finishes
1.	19443-WZC		1-1/16"	3"	3-3/4"	AN, ALB
2.	19436-WZC		1-1/4"	96 mm	6-1/4"	AN, ALB
3.	19427-WZC	1-3/8"	1-1/8"			AN, ALB

U.S. Design Patents: 19433: USPN D551055, 19436: USPN D553943, 19427: USPN D550534

Whistler

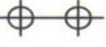

#	Part number					Finishes
1.	19545-AZ		1-1/4"	3-1/2"	4-1/16"	Aged Bronze
2.	19609-AZ	1-5/8"	1-5/16"			Aged Bronze
3.	19537-AZ		1-1/4"	4"	5"	Aged Bronze
4.	19539-AZ		1-3/8"	6"	7-1/8"	Aged Bronze
5.	19619-AZ	oval	1-1/4"		1-7/8"	Aged Bronze
6.	19607-AZ	1-3/8"	1-3/16"			Aged Bronze
7.	19545-AI		1-1/4"	3-1/2"	4-1/16"	Aged Iron
8.	19609-AI	1-5/8"	1-5/16"			Aged Iron
9.	19537-AI		1-1/4"	4"	5"	Aged Iron
10.	19539-AI		1-3/8"	6"	7-1/8"	Aged Iron
11.	19619-AI	oval	1-1/4"		1-7/8"	Aged Iron
12.	19607-AI	1-3/8"	1-3/16"			Aged Iron

Orleans

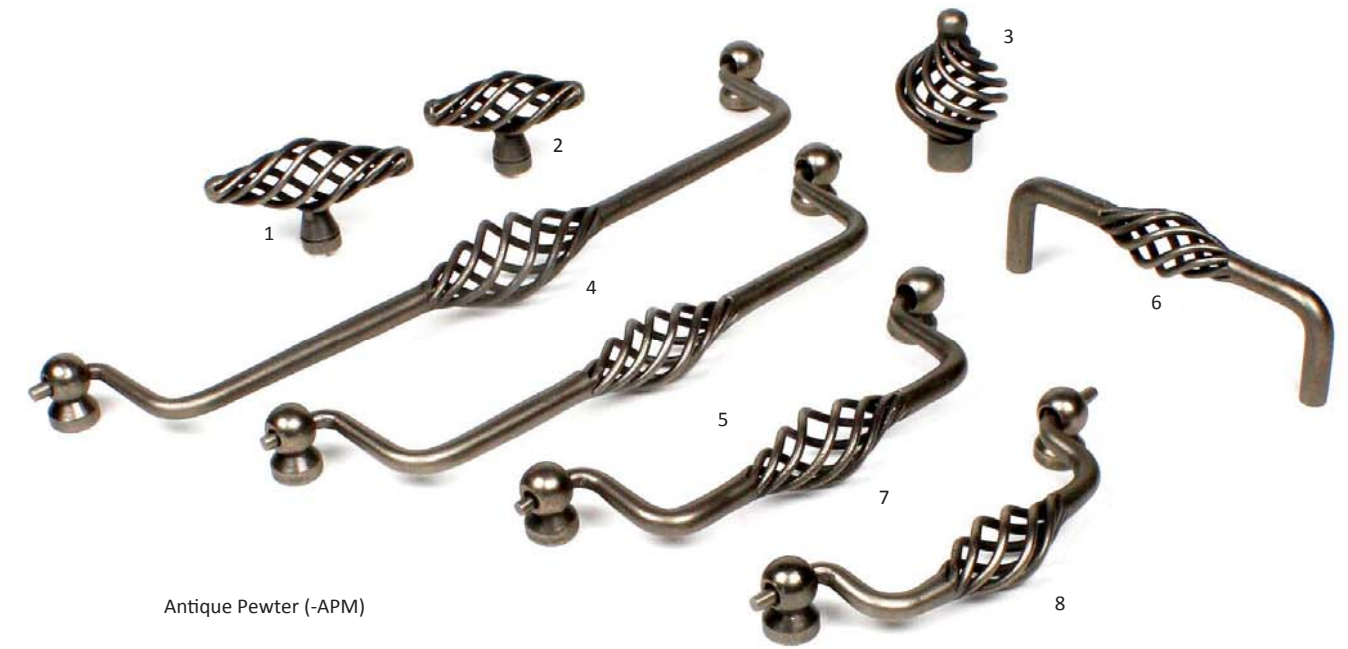

Antique Pewter (-APM)

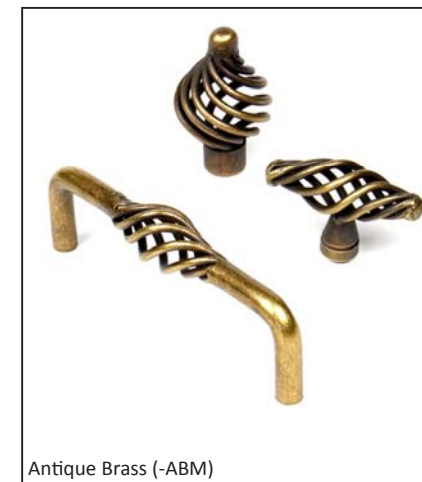





Antique Brass (-ABM)



Matt Black (-MB)



Natural Rust (-NR)

#	Part Number					Additional Available Finishes
1.	44002-APM	15/16"	1-3/8"		2-3/8"	ABM, MB, NR
2.	44001-APM	3/4"	1-3/8"		2"	ABM, MB, NR
3.	42417-APM	1-15/16"	2-1/16"			ABM, MB, NR
4.	44039D-APM		2-7/16"	10"	10-3/4"	ABM, MB, NR
5.	44039B-APM		2-3/8"	7-1/2"	8-3/8"	ABM, MB, NR
6.	44047-APM		1-1/2"	4"	4-3/8"	ABM, MB, NR
7.	44038-APM		2-1/4"	5"	5-3/4"	ABM, MB, NR
8.	44037-APM		2"	4"	4-1/2"	ABM, MB, NR

Plymouth

Athena



Oil Rubbed Bronze (-10B)

Dull Satin Nickel (-DSN)







#	Part Number					Additional Available Finish
1.	16543-10B		1-1/16"	3"	3-9/16"	DSN
2.	11426-10B	1-1/4"	1"			DSN
3.	12405-10B	1-1/4"	1-1/8"			DSN
4.	11626-10B	1-1/4"	1"			DSN
5.	11428-10B	1-1/2"	1-1/8"			DSN
6.	13117-10B	oval	1-1/4"		1-3/8"	DSN
7.	13033-10B		7/8"	3"	3-7/16"	DSN
8.	13333-10B		15/16"	3"	3-3/8"	DSN
9.	12355-10B		1-3/16"	3-1/2"	3-7/8"	DSN
10.	12353-10B		1-3/16"	3"	3-3/8"	DSN
11.	10335-10B	1-1/4"	1-1/16"			DSN

#	Part Number					Finishes
1.	28286-DSN		1-1/4"	96 mm	4-3/16"	Dull Satin Nickel
2.	22628-DSN	oval	1-3/16"		1-1/2"	Dull Satin Nickel
3.	22628-14	oval	1-3/16"		1-1/2"	Polished Nickel
4.	28286-14		1-1/4"	96 mm	4-3/16"	Polished Nickel
5.	28286-APH		1-1/4"	96 mm	4-3/16"	Antique Pewter Hand Polished
6.	22628-APH	oval	1-3/16"		1-1/2"	Antique Pewter Hand Polished
7.	22628-OB	oval	1-3/16"		1-1/2"	Oil Rubbed Bronze
8.	28286-OB		1-1/4"	96 mm	4-3/16"	Oil Rubbed Bronze





Aztec



#	Part Number					Finishes
1.	21306-AB	1-1/4"	1-1/16"			Brushed Antique Brass
2.	21306-15	1-1/4"	1-1/16"			Satin Nickel
3.	28433-AB		1"	3"	5-1/4"	Brushed Antique Brass
4.	28433-15		1"	3"	5-1/4"	Satin Nickel
5.	28433-AP		1"	3"	5-1/4"	Antique Pewter
6.	28433-AC		1"	3"	5-1/4"	Antique Copper
7.	21306-AP	1-1/4"	1-1/16"			Antique Pewter
8.	21306-AC	1-1/4"	1-1/16"			Antique Copper

Bocci



#	Part Number					Finishes
1.	21537-15		1-5/16"	4"	4-7/16"	Satin Nickel
2.	21537-AZC		1-5/16"	4"	4-7/16"	Antique Bronze/Copper
3.	29873-15		1-3/16"	3"	3-1/2"	Satin Nickel
4.	29873-AZC		1-3/16"	3"	3-1/2"	Antique Bronze/Copper
5.	28127-15	1-3/8"	1-1/8"			Satin Nickel
6.	28127-AZC	1-3/8"	1-1/8"			Antique Bronze/Copper
7.	28625-15	1-1/8"	1-3/16"			Satin Nickel
8.	28625-AZC	1-1/8"	1-3/16"			Antique Bronze/Copper

Devon

Tuscana



Weathered Brass (-WB)

Antique Nickel (-AN)

Matt Satin Nickel (-MSN)

Ancient Bronze (-ABZ)

Oil Rubbed Bronze (-10B)

#	Part Number					Finishes
1.	29128-DSN		1-9/16"	128 mm	5-3/4"	Dull Satin Nickel
2.	29028-DSN	1"	1-9/16"		1-9/16"	Dull Satin Nickel
3.	29128-APH		1-9/16"	128 mm	5-3/4"	Antique Pewter Hand Polished
4.	29028-APH	1"	1-9/16"		1-9/16"	Antique Pewter Hand Polished
5.	29128-RB		1-9/16"	128 mm	5-3/4"	Regent Bronze
6.	29028-RB	1"	1-9/16"		1-9/16"	Regent Bronze

#	Part Number					Additional Available Finishes
1.	17025-WB	1-1/4"	1-1/8"			MSN, ABZ, 10B
2.	15343-WB		1-1/8"	3"	4-3/8"	MSN, ABZ, 10B
3.	15343-AN		1-1/8"	3"	4-3/8"	MSN, ABZ, 10B
4.	17025-AN	1-1/4"	1-1/8"			MSN, ABZ, 10B

Nordic I







Antique Pewter/Gray Crackle (-APGY)



Satin Nickel /White (-15WT)



Satin Nickel/Cream Crackle (-15CR)

#	Part Number					Additional Available Finishes
1.	27438-APGY		1-1/2"	128 mm	6-1/8"	15WT, 15CR
2.	27449-APGY		1-3/4"	224 mm	9-3/4"	15WT, 15CR
3.	27429-APGY		1-3/4"		3-3/8"	15WT, 15CR
4.	27415-APGY	1-3/16"	1-3/8"			15WT, 15CR
5.	27417-APGY	1-3/8"	1-3/8"			15WT, 15CR

Nordic II



Polished Chrome/White (-26WT)



Polished Chrome/Plain Black (-26BK)



Oil Rubbed Bronze/Brown Crackle (-OBBC)

#	Part Number					Additional Available Finishes
1.	27438-26WT		1-1/2"	128 mm	6-1/8"	26BK, OBBC
2.	27429-26WT		1-3/4"		3-3/8"	26BK, OBBC
3.	27417-26WT	1-3/8"	1-3/8"			26BK, OBBC